



## Operation and Maintenance Manual for the HW 50 & TW 50 Soldering Systems

P/N 5050-0533 Rev 3-05-prm

	<b>Voltage</b>	<b>Part Number</b>
HW 50 HEATWISE™ System	120 VAC	8007-0425
HW 50 HEATWISE™ System	230 VAC	8007-0426
HW 50 HEATWISE™ System w/ Instant Setback Cubby	230 VAC	8007-0456
HW 50 HEATWISE™ System w/ Instant Setback Cubby	230 VAC	8007-0457
TW 50 TEMPWISE™ System	120 VAC	8007-0458
TW 50 TEMPWISE™ System	230 VAC	8007-0459
TW 50 TEMPWISE™ System w/ Instant Setback Cubby	120 VAC	8007-0460
TW 50 TEMPWISE™ System w/ Instant Setback Cubby	230 VAC	8007-0461

TITLE	PAGE
General Information .....	3
Introduction.....	3
Specifications .....	3
Parts Identification.....	4
Safety .....	5
Safety Guidelines .....	5
System Set-Up .....	5
Mounting Options .....	5
Tip & Tool Stand.....	6
Adjusting the Angle of the Cubby .....	6
Handpiece Connection .....	6
System Power Up .....	6
Definitions.....	7
Operation.....	7
HW 50 Heat Wise System .....	7
Auto-Setback and Auto-Off Features .....	8
TW 50 Temp Wise System.....	8
Calibrating the TW 50.....	10
Programming the TW 50 .....	11
Optional Instant Setback Cubby.....	14
Corrective Maintenance .....	14
Replacement Power Modules .....	14
Packing Contents .....	15
Service .....	15
“SODRTEK by PACE” LIMITED WARRANTY STATEMENT.....	16
Contact Information.....	17

## General Information

### Introduction

Thank you for purchasing Sodr-Tek's HW 50 or TW 50 Soldering System. This manual will provide you with the information necessary to properly set up, operate, and maintain your system. Both systems are available in either 115 VAC or 230 VAC versions, which incorporate a highly responsive, closed loop control system providing up to 55 Watts of total output power. The 230 VAC version system bears the CE Conformity Marking, which assures the user that it conforms to EMC 89/336/EEC.

The 115 VAC version systems conform to FCC Emission Control Standard, Title 47, Subpart B, Class A. This standard is designed to provide reasonable protection against harmful interference when the equipment is operated in a commercial environment.

### Specifications

<b>Specification</b>	<b>HW 50</b>	<b>TW 50</b>
Power Requirements	97-127 VAC 50/60 Hz, 80 W Max or 197-253 VAC 50/60 Hz, 80 W Max	97-127 VAC 50/60 Hz, 80 W Max or 197-253 VAC 50/60 Hz, 80 W Max
HW 50 Dimensions	184mm H x 107mm W x 122mm D (7.25" H x 4.2" W x 4.8" D)	184mm H x 107mm W x 122mm D (7.25" H x 4.2" W x 4.8" D)
Tip & Tool Stand Dimensions	71mm H x 88mm W x 195 mm D (2.8" H x 3.5" W x 7.7" D)	71mm H x 88mm W x 195 mm D (2.8" H x 3.5" W x 7.7" D)
HW 50 Weight	1.6 Kgs (3.5 lbs)	1.6 Kgs (3.5 lbs)
TD-100 Handpiece Weight	88.2 g (3.1 oz)	88.2 g (3.1 oz)
Tip to Ground Resistance	< 2 Ohms	< 2 Ohms
Temperature Stability	Within +/- 5 °C (9 °F), idle tip temperature	Within +/- 5 °C (9 °F), idle tip temperature
Absolute Temperature Accuracy	N/A	Within +/- 15 °C (27 °F), idle tip temperature. Can be calibrated for exact temperature
Heat Level/Temperature Range	260 °C - 454 °C (500 °F – 850 °F) Available Power Module Heat Levels: 5, 5.5, 6, 6.5, 7, 7.5, 8, & 8.5	260 °C - 454 °C (500 °F – 850 °F)

**Parts Identification**

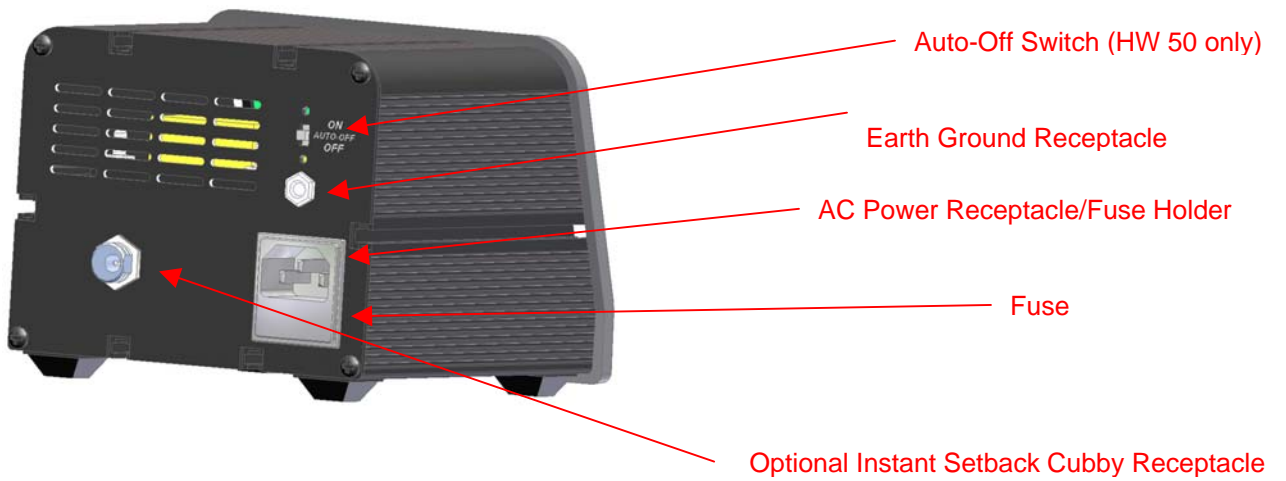
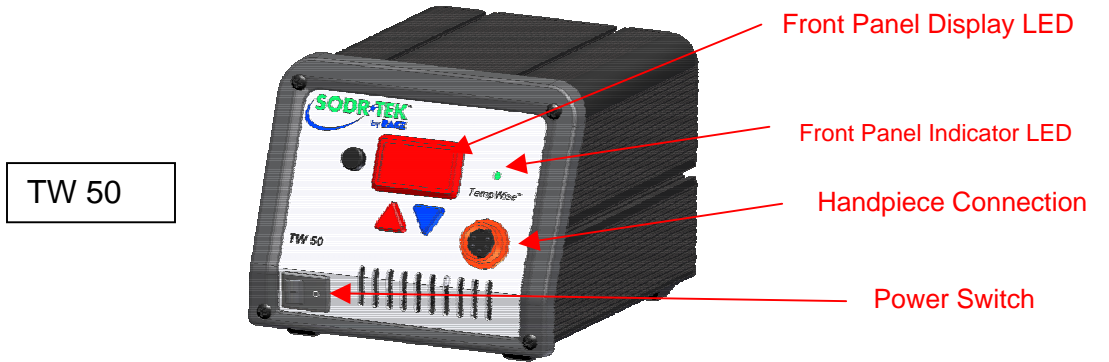
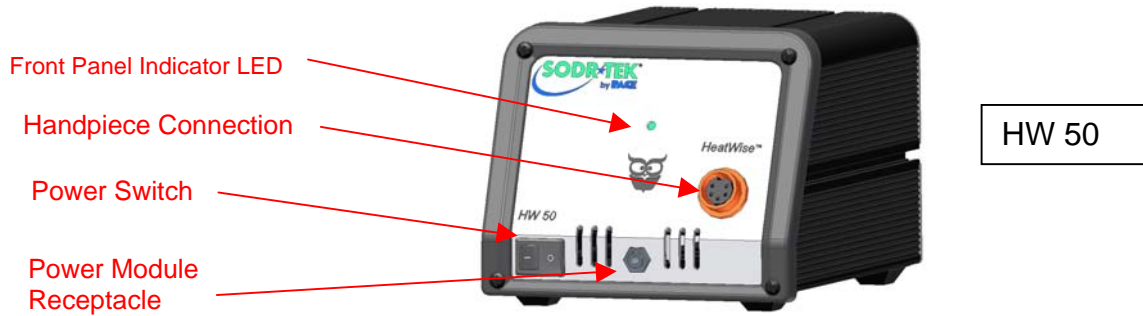

## Safety

### Safety Guidelines

The following are safety precautions that personnel must understand and follow when using or servicing this product.

1. **POTENTIAL SHOCK HAZARD** - Repair procedures on PACE products should be performed by Qualified Service Personnel only. Line voltage parts may be exposed when the equipment is disassembled. Service personnel must avoid contact with these parts when troubleshooting the product.
2. To prevent personnel injury, adhere to safety guidelines in accordance with OSHA and other applicable safety standards.
3. Heater Cartridge Tips are hot when the handpiece is powered on and for a period of time after power off. **DO NOT** touch the cartridge. Severe burns may result.
4. PACE Tip & Tool Stands and handpiece cubbies are designed specifically for use with the associated handpiece and houses it in a manner that protects the user from accidental burns. Always store the handpiece in its holder. Be sure to place the handpiece in its holder after use and allow for cooling before storing.
5. Always use PACE systems in a well ventilated area. A fume extraction system such as those available from PACE are highly recommended to help protect personnel from solder flux fumes.
6. Exercise proper precautions when using chemicals (e.g., solder paste). Refer to the Material Safety Data Sheet (MSDS) supplied with each chemical and adhere to all safety precautions recommended by the manufacturer.

### System Set-Up

Set up the HW 50 or TW 50 system using the following steps and associated images.

1. Store the shipping container in a convenient location. Reuse of these containers will prevent damage if you store or ship your system(s).
2. Place the Power Switch in the "OFF" or "0" position.

Power Switch



### Mounting Options

The system can be placed directly on a workbench or mounted under a workbench or shelf to conserve space (**optional mounting bracket, PN 1321-0609-P1 is sold separately**). Mount the system in this way (TW 50 shown):

1. Mount the bracket in the desired location (fasteners not supplied).
2. Insert the 2 Mounting Screws (head first) into the power source mounting slots.
3. Place the washers over the screws.
4. Fit the power source between the bracket's support arms and place the screws into the slots on the support arms.
5. Place the nut on the screw and tighten by hand.

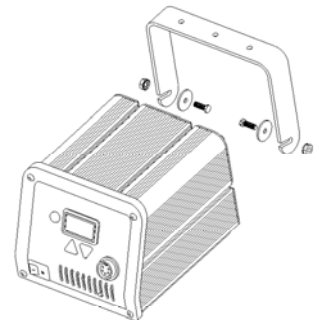

6. Angle the power source so the operator can see the front panel easily and tighten the nuts with a wrench or pliers.

### Tip & Tool Stand

The Tip & Tool Stand can be set on a workbench unattached, or can be mounted to the power source. If the HW 50 or TW 50 is to be mounted under the workbench or shelf using the optional mounting bracket, the Tip & Tool Stand should not be mounted to the power source.

1. To attach the stand to the power source:
  - a) Insert the 2 large hex head Mounting Screws (head first) into the lower "T" slot on the side of the power source case as shown.
  - b) Place the Tip & Tool Stand beside the power source. Insert ends of the 2 Mounting Screws into the 2 Tip & Tool Stand mounting holes as shown.
  - c) Install a Thumb Nut onto the end of each Mounting Screw and tighten Thumb Nuts.
  - d) If the Optional Instant Setback Cubby is purchased (Part Number 6019-0071-P1), connect the Cubby connector plug into the Instant Setback Cubby Receptacle in the following manner.
2. Place the handpiece into its Tip & Tool Stand.

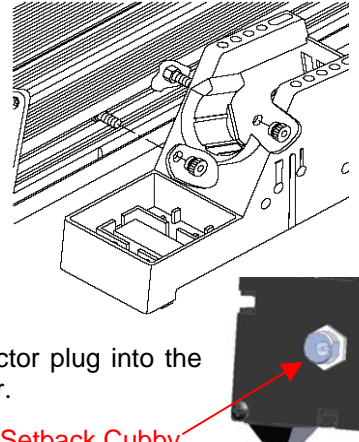

Instant Setback Cubby Receptacle

### Adjusting the Angle of the Cubby

The angle of the standard Handpiece Cubby may be adjusted by loosening the angle thumb screw slightly, adjusting the cubby to the desired angle, and tightening the thumb screw. If the instant setback cubby was selected the cubby angle is not adjustable.



Thumb Screw

### Handpiece Connection

Connect the handpiece connector plug into the Power Receptacle in the following manner.

**NOTE:** Only connect the handpieces with the red connectors to the HW 50 and TW 50.

1. Align guide on the connector with slot on power receptacle.
2. Insert connector into power receptacle.
3. Turn the connector housing clockwise to lock in place.

### System Power Up

1. Insert the female end of the power cord into the AC Power Receptacle on the rear panel of the power source.
2. Plug the prong end (male end) of the power cord into an appropriate 3 wire grounded AC supply receptacle.

**CAUTION:** To insure operator and ESD/EOS safety, the AC power supply receptacle must be checked for proper grounding before initial operation.

**NOTE:** Ensure that the system is placed in a well-ventilated area. Fume extraction equipment is recommended

## Definitions

Please read and become familiar with the definitions of each of the following terms that are used repeatedly in the following operational procedures.

Please read and become familiar with the definitions of each of the following terms that are used repeatedly in the following operational procedures.

**Auto-Off:** Safety feature that turns power off (10-90 minutes, settable in 10 minute increments for TW 50; 30 minutes for HW 50) after the system has entered Temperature Setback.

**Normal Operation:** Normal operating mode of the system in which the Operating Tip Temperature is displayed.

**Password:** The Password feature of the TW 50 system will prevent unauthorized alteration of stored system temperature parameters and feature settings. If a Password has been installed, the LED Display will display an instruction to enter the Password (a 3 digit number selected using the scroll up/down keys on the system front panel) when a setting change is attempted.

**Programming Menu:** The interface used to program the system features parameters (e.g., temperature limits, password, setback time). TW 50 ONLY.

**Temperature Setback:** System feature that will independently set back the Set Tip Temperature to 177°C (350°F) after a user selected or preset period of handpiece inactivity (10-90 minutes, settable in 10 minute increments for TW 50; 30 minutes for HW 50).

## Operation

### **HW 50 Heat Wise System**

The HW 50 requires the use of a Power Module. The Power Module selects the desired heat level for operation. The HW 50 comes standard with three Power Modules, Heat Levels 6.5, 7, & 7.5. Additional Power Modules are available in heat levels of 5, 5.5, 6, 8, and 8.5. Please refer to the Accessory Section for Power Module part numbers. A heat level of 5 corresponds to a nominal temperature of 500 °F; a heat level of 6.5 corresponds to a temperature of 650 °F, etc. Actual measured temperatures on the surface of the tip may vary due to tip geometry.

Front Panel LED



Power Module Receptacle

Verify the following:

- a) Handpiece connection to the power source.
- b) Power cord connection between an appropriate AC supply receptacle and the power source.

If the power is turned on while a Power Module is not installed, or if the Power Module is removed during operation, the system will turn itself off and the LED indicator light on the front panel will turn red. To operate the unit, please make sure the set-up procedure has been followed, then follow the procedure below.

1. Install the desired Tip Cartridge.
2. Install the desired Power Module into the Power Port on the front of the unit.

3. The LED indicator will turn amber while the tip is heating to the desired performance level.
4. Once the tip has reached the desired heat level, the LED indicator will turn green and the system is ready to use.

### Auto-Setback and Auto-Off Features

The HW 50 system comes standard with Auto-Setback and Auto-Off Features. These are pre-programmed for 30 minute Setback and 30 minute Auto Off, which can be turned off by the switch on the back of the unit. When Setback mode has been entered, the heat level will be adjusted to 3.5.

The following chart explains the function of the LED Indicator Light.

	LED Indicator Activity
Power On	Amber → Green
Normal Operation	Green
Tip Cartridge Removed	Red
Heater Open Sensor	Red
System In SetBack	Amber or Green*
System in Auto-Off	
System reactivated after Auto-Off	Amber → Green*

\*The LED will be Amber or Green depending on the color when it entered Setback, or Auto Off.

### TW 50 TempWise System

The TW 50 system is very easy to adjust and operate. The following instructions detail system features and operation of the system. Information regarding changing of system options (e.g., Temperature Setback time, Auto Off) is contained in the "Programming Your System" portion of this manual.

1. Ensure that the Set-Up procedure has been performed. Verify the following:
  - a) Handpiece connection to the power source.
  - b) Proper tip installed in handpiece.
  - c) Power cord connection between an appropriate AC supply and the power source.
2. Turn the Power Switch On ("I"). The display will begin to increase as the TD 100 handpiece heats up.
3. Press the Scroll Up (▲) Key. The Set Temperature is now displayed, immediately perform step 4.

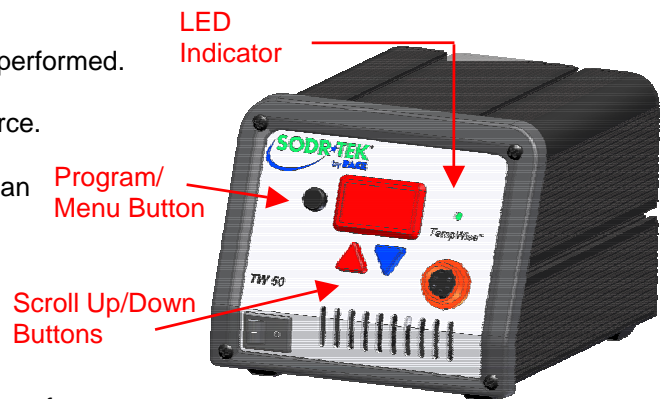

**NOTE:** If a Password has been previously programmed into the system, "EP" will be appear on the LED Display at this point. When this message appears, the operator must enter the correct Password before adjusting the temperature.

4. Adjust the temperature by pressing and holding Scroll Up (▲) Key or Scroll Down (▼) key. Observe the display as the Set Temperature increases first in increments of 5°, then in increments of 10°. When the desired temperature is reached, release the key.







**NOTE:** The Set Temperature can only be within the set temperature limits. If the lower limit is reached, the display will read off. If the upper limit has been reached, the display will read "HiL". Temperature limits can be adjusted in the programming menu. See "Programming Your System" section.

5. Observe the Digital Readout as the temperature reaches and stabilizes at the Set Tip Temperature.
6. The system can be manually forced into Temperature Setback by pressing and holding the Scroll Down (t) Key and the Scroll Up (▲) Key.
7. When the display begins to blink, the system is in Temperature Setback mode and will reduce the set temperature to 177°C (350°F). **NOTE:** If Auto Off has been enabled in the programming menu, the system will enter Auto Off (temperature Off and LED Display flashing "Off") after the preset time of handpiece inactivity. Auto Off can be exited by pressing any key.
8. To exit Temperature Setback mode, perform any one of the following:
  - a) Press and release a Key (⏪, (▲) or (▼)). This is the preferred method.
  - b) Wipe the hot handpiece tip on a wet sponge to thermally load the tip.
  - c) Turn the Power Switch Off ("0") and then back on ("I").
9. The system is now in normal operation. Observe the LED Display as the tip temperature reaches and stabilizes at the Set Temperature. Allow time for the temperature to stabilize at the Set Temperature before using.

**NOTE:** Read the "Programming Your System" sections of this manual to utilize the full capabilities of the system.

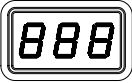

### LED Display, Normal Operation

The LED Display provides a 3-digit display of temperature information. The LED Display will show:

1. A display of "888" on initial power up to ensure that all LEDs on the display are working. 
2. A display of the software version of the installed microprocessor (e.g., "1-1") for 1 second on initial power up after the "888" is displayed.
3. Actual tip temperature of the connected handpiece during normal operation. The tip temperature displayed will flash when the system is in Temperature Setback. 
4. The displayed temperature will decrease and stabilize at 177°C (350°F) when the system is in Temperature Setback.
5. "OFF" when the Set Tip Temperature has been set to Off (below minimum set tip temperature). Refer to the "Programming Your System" portion of this manual. 
6. "OFF" plus the LED Display will be flashing when the unit has entered Auto Off. Refer to the "Programming Your System" section of this manual.
7. Error messages ("OSE" or "CEE") if a system fault is detected. Refer to the "Corrective Maintenance" portion of this manual. 

### LED Display, Temperature Adjust Mode

The LED Display will show the following when adjusting the desired Set Tip Temperature.

1. The Set Tip Temperature.
2. "HiL" (High Temperature Limit) when adjusting the set tip temperature and the maximum allowable temperature is exceeded. Refer to the "Programming Your System" portion of this manual. 
3. "OFF" (Low Temperature Limit) when adjusting the set tip temperature and the minimum allowable temperature is exceeded. Refer to the "Programming Your System" section of this manual. 

4. "EP" will be displayed if a Set Tip Temperature adjustment is attempted and a Password has been stored in system memory. As the Password is entered, the display will change to the Set Tip Temperature if the entered Password matches the stored Password.
5. "no" will be displayed if the entered password does not match the stored Password.



### Temperature Setback Mode

To preserve tip life and save energy, the TW 50 system can be programmed to automatically set back its Tip Temperature to 177°C (350°F) after a selected period of handpiece inactivity. The LED Display will blink "177" or "350" depending on the selected temperature scale. As received from the factory, this feature is enabled. Refer to number 9 in the "Programming Your System" section of this manual to disable or adjust the time-out period of this feature. The operator can also force the system into Temperature Setback.

**Activating Temperature Setback:** There are two ways to activate the Temperature Setback feature.

1. **AUTOMATIC ACTIVATION:** The system can be programmed so that this feature will automatically activate after a pre-selected period (10-90 minutes) of handpiece inactivity. See the "Programming Your System" section for details on programming this feature.
2. **MANUAL ACTIVATION:** The operator can manually force the system into Temperature Setback by performing the following procedure.
  - a. Press and hold the Scroll Down (▼) Key and the Scroll Up (▲) Key.
  - b. Release both keys.

**Exiting Temperature Setback:** Listed below are 3 ways to exit Temperature Setback.

1. Press and release any key on the front panel ((⏪), (▲) or (▼)). This is the preferred method.
2. Wipe the hot handpiece tip on a wet sponge to thermally load the tip.
3. Turn the Power Switch "OFF" ("0") and then back "ON" ("1").

Set Tip Temperature values will be restored. For optimum performance, do not attempt to use the attached handpiece until the Set Tip Temperature is achieved and the LED indicator is green.

### Auto Off Safety System Mode

When enabled, the Auto Off safety system of the TW 50 system turns off the power to the handpiece 10-90 minutes after entering Temperature Setback. When the system has entered Temperature Setback, an Auto Off timer within the system circuitry will start running if Auto Off is turned on. Refer to number 10 in the Programming Menu. When Auto Off has activated, the LED Display will blink "OFF".

1. If any key is pressed during the selected time out period, the Auto Off timer is reset. The system will return to normal operation.
2. At the end of the time out period, the system will enter Auto Off. Power is turned off to the heater and the LED Display will show a flashing "OFF" and the LED indicator will turn red.

**Exiting Auto Off:** Auto Off can be exited; returning to normal operation by:

1. Pressing and releasing any key on the front panel. (⏪), (▲) or (▼), or
2. By turning the Power Switch OFF ("0") and then back ON ("1").

### Using the TW 50 Calibration Feature

The new TW 50 systems feature an all-new calibration procedure. The system is calibrated so the display matches the measured tip temperature using your own testing method. This new PACE feature allows any type of temperature verification device to be utilized to complete the simple procedure. Calibration can be completed, as often as you like, in order to meet your own internal specifications.

The steps for the procedure are:

1. Remove any offset from the system by disconnecting the handpiece from the system; the LED should go to amber.
2. Set the TW 50 to 700°.
3. Record the actual temperature of the tip from your temperature verification device.
4. Place the TW 50 into the Calibration mode. This can be achieved by starting with the system power switch in the off position. Press and hold the Program key and the UP (▲)key while turning the system on. Release both keys when the display reads “1.1”, once released the display will read “tIP.” Please note that if the system has already been calibrated that the display will read “CSO” at this time. To clear this, simply momentarily disconnect the handpiece from the system.
5. Use the UP (▲)and DOWN (▼)keys to enter the temperature that you recorded by the temperature verification device.
6. Press the PROGRAM key to exit. Upon exiting, LED will illuminate green.

**NOTE:** The system will display “CSO” (Clear System Offset) if an offset exists within the system.

The system will prompt the user to calibrate under specific conditions, for example, when the handpiece has been removed. The system indicates whether calibration is required or not through the color of the LED Indicator Light. When the LED Indicator is Green, the system is calibrated and ready for use, when it is Amber, the system may need to be calibrated, and when it is Red, the system should be calibrated. The following chart explains the function of the LED Indicator Light.

	<b>LED Indicator Activity</b>
Power On	Amber
Calibration Complete	Green
Tip Cartridge Removed	Red
Heater Open Sensor	Red
System In SetBack	Amber or Green*
System in Auto-Off	Amber or Green*
System reactivated after Auto-Off	Amber or Green*

\*The LED will be Amber or Green depending on the color when it entered Setback, or Auto Off.

**NOTE:** Before calibration is attempted, the system should be allowed to reach set temperature. After turning on the system or changing tip cartridges, wait for at least 15 seconds before calibrating.

### **Programming Your System**

The menu driven LED Display of the TW 50 system allows you to easily customize your system. By accessing the programming menu, you can:

- Enter, remove or change a Password.
- Set the Default Temperature scale to °F or °C as desired.
- Change the Upper and Lower Temperature limits.
- Enable or disable the Temperature Setback feature and adjust the time-out period.
- Enable or disable the Auto Off feature and adjust the time-out period.
- Enable or disable the Calibration mode.

The following instructions should be performed to familiarize the operator with the system.

## Entering the Programming Menu

1. Place Power Switch in the "OFF" ("0") position.
2. Press and hold the Program Key (Ⓢ) while turning on the Power Switch ("I" position).

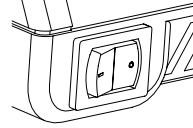

## Password

3. The LED Display will display the version of the microprocessor and change to read "P--" or "EP".
4. If the display reads "EP", a Password has been stored in system memory. Enter the 3 digit Password (using the scroll up/down keys). If the Password entered is incorrect, "no" appears on the display and the system then returns to normal operation. If this occurs, repeat steps 1 through 5 and enter the correct Password.
5. The LED Display reads "P--". Choose one of the following options:
  - a) Press the Program Key (Ⓢ) to keep the currently stored Password (including no Password).
  - b) Press and release the Scroll Up(▲) or Scroll Down(▼) Key to enter a new password.
  - c) Set the display to "000" for no password.

## Temperature Scale

6. The LED Display now shows the stored default Temperature Scale (°C or °F temperature shown on LED Display). Choose one of the following:
  - a) Press the Program Key (Ⓢ) to keep the stored default Temperature Scale.
  - b) Press and release the Scroll Up(▲) Key to change the default Temperature Scale. Press and release the Program Key.



## Temperature Limits

7. The LED Display now shows the stored default High ("Hi") Temperature Limit with the display alternating to show "Hi" and the stored limit. Choose one of the following:
  - a) Press and release the Program Key (Ⓢ) to keep the stored High Temperature Limit.
  - b) Press and release the Scroll Up(▲) Key to increase the stored High Temperature Limit (up to 454°C, (850°F)). Press and release the Program Key to proceed to the next step.
  - c) Press and release the Scroll Down(▼) Key to decrease the stored High Temperature Limit. Press and release the Program Key to proceed to the next step.
8. The LED Display now shows the stored default Low ("Lo") Temperature Limit with the display alternating to show "Lo" and the stored limit. Choose one of the following:
  - a) Press and release the Program Key (Ⓢ) to keep the stored Low Temperature Limit (260°C, 500°F).
  - b) Press and release the Scroll Up(▲) Key to increase the stored Low Temperature Limit. Press and release the Program Key to proceed to the next step.
  - c) Press and release the Scroll Down(▼) Key to decrease the stored Low Temperature Limit. Press and release the Program Key to proceed to the next step.

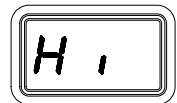

## Temperature Setback

9. The LED Display now shows the stored Temperature Setback time as "S-X" (x=0 thru 9). Time is shown as tens of minutes (e.g., "S-3" equals 30 minutes). A display of "S- 0" indicates that Setback is disabled. Choose one of the following:



- Press and release the Program Key (☞) to keep the currently stored Temperature Setback time.
- Press and release the Scroll Up(▲)Key to enable and/or increase the stored Temperature Setback time. Press and release the Program Key to proceed to the next step.
- Press and release the Scroll Down(▼)Key to decrease or disable the stored Temperature Setback time. Press and release the Program Key to proceed to the next step.

### Auto Off

10. The LED Display now shows the stored Auto Off time as "AOx" (x=0 thru 9). Time is shown as tens of minutes (e.g., "AO3" equals 30 minutes). A display of "AO0" indicates that Auto Off is disabled. Choose one of the following:



- Press and release the Program Key (☞) to keep the currently stored Auto Off time.
- Press and release the Scroll Up(▲)Key to enable and/or increase the Auto Off. Press and release the Program Key to proceed to the next step.
- Press and release the Scroll Down(▼)Key to decrease or disable the stored Auto Off time. Press and release the Program Key to proceed to the next step.

### Exiting the Programming Menu

11. The LED Display now reads "End". The Set-Up Mode procedure is now complete. Choose one of the following steps:

- Press and release the Scroll Up(▲)Key to exit Set-Up Mode and return to normal operation.
- Press and release the Scroll Down(▼)Key to return to the start of the Set-Up Mode procedure. Go back to step 4.



### Factory Settings

TW 50 systems come equipped with a number of features, which may be adjusted as desired by the user. Listed below are the features and factory settings of each. To change and/or learn about any of these features, refer to the applicable part of the "Programming Your System" section of this manual.

Feature	Factory Setting
Password	None Entered
Default Temperature Scale (°C/°F)	°F for 115 VAC Systems °C for 230 VAC Systems
"HI" (Upper) Temperature Limit	454 °C (850 °F)
"LO" (Lower) Temperature Limit	260 °C (500 °F)
Set Temperature	"OFF"
Temperature Setback	Enabled, 30 minutes
Auto Off	Enabled, 60 minutes

### Factory Settings

**Using the Optional Instant Setback Cubby (Part Number 6019-0071-P1)**

The HW 50 and TW 50 can be used with the optional Instant Setback Cubby. When the TD-100 handpiece is inserted into the Cubby, the system will automatically go into the Setback Mode after 45 seconds of non-use. Once the Handpiece is removed from the Cubby, it will return to normal operation.

Instant Setback Cubby Cable

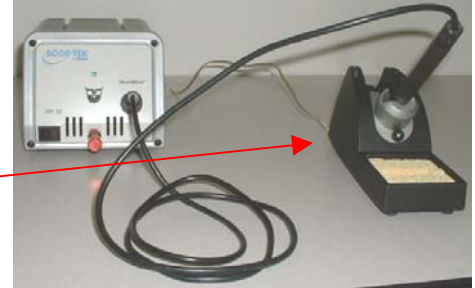

**Corrective Maintenance**

**Handpieces**

Please refer to the TD-100/MT-100 Handpiece Manual for the maintenance procedures.

**Power Source**

Refer to the table below. Most malfunctions are simple and easy to correct.

Symptom	Probable Cause	Solution
No power to system	Blown Fuse	Replace the fuse (located in the AC Receptacle Fuse Holder) with one of the same rated value.
	No Supply Voltage	Verify that the AC outlet is active.
Handpiece will not heat	Defective Heater	Change Tip Cartridge. Refer to the TD-100/MT-100 Handpiece manual for the maintenance procedures.
	Power Source Malfunction	Contact PACE

Power Source Corrective Maintenance

**Replacement Power Modules**

	Description	PACE Part Number
		Power Modules
	5/Green	1207-0362-01-P1
	5.5/Blue	1207-0362-02-P1
	6/Orange	1207-0362-03-P-1
	6.5/Gold	1207-0362-04-P1
	7/Red	1207-0362-05-P1
	7.5/Purple	1207-0362-06-P1
	8/Black	1207-0362-07-P1
	8.5/Silver	1207-0362-08-P1

**Packing Contents**

<b><u>Description</u></b>	<b><u>HW 50 System</u></b>	<b><u>HW 50 E System</u></b>
Power Supply	8007-0425	8007-0426
Power Cord	1332-0094	1332-0093
Handpiece	TD-100 (6010-0132-P1)	TD-100 (6010-0132-P1)
Tip & Tool Stand	1257-0258-P1	1257-0258-P1
Power Module Kit Contains 6.5, 7, & 7.5 Modules	1207-0365-P3	N/A
Hot Grip Removal Pad	1100-0307-P1	1100-0307-P1

**Service**

Please contact PACE or your local distributor for service and repair.

## **SODR-TEK LIMITED WARRANTY STATEMENT**

### **Limited Warranty**

Seller warrants to the first user that products manufactured by it and supplied hereunder are free of defects in materials and workmanship for a period of one (1) from the date of receipt by such user. This Warranty as applied to blowers and motor pumps is limited to a period of six (6) months. Other brand equipment supplied but not manufactured by PACE are covered under their respective manufacturer's warranty in lieu of this Warranty.

This warranty does not cover wear and tear under normal use, repair or replacement required as a result of misuse, improper application, mishandling or improper storage. Consumable items such as tips, heaters, filters, etc. which wear out under normal use are excluded. Failure to perform recommended routine maintenance, alterations or repairs made other than in accordance with Seller's directions, or removal or alteration of identification markings in any way will void this warranty. This warranty is available only to the first user, but the exclusions and limitations herein apply to all persons and entities. SELLER MAKES NO OTHER WARRANTY, EXPRESS OR IMPLIED, AND MAKES NO WARRANTY OF MERCHANTABILITY OR FITNESS FOR A PARTICULAR PURPOSE.

Seller will, at its option, repair or replace any defective products at its facility or other location approved by it at no charge to user, or provide parts without charge for installation by the user in the field at user's expense and risk. User will be responsible for all costs of shipping equipment to Seller or other location for warranty service.

EXCEPT FOR THE REMEDY ABOVE DESCRIBED, UNLESS OTHERWISE REQUIRED BY APPLICABLE LAW, SELLER WILL HAVE NO OTHER OBLIGATION WITH REGARD TO ANY BREACH OF WARRANTY OR OTHER CLAIM WITH RESPECT TO THE PRODUCTS, OR LIABILITY FOR ANY DIRECT, INDIRECT, CONSEQUENTIAL, OR INCIDENTAL LOSS OR DAMAGE CAUSED BY OR OCCURRING IN CONNECTION WITH ANY OF THE PRODUCTS.

Warranty service may be obtained by contacting the appropriate PACE Company or local Authorized PACE distributor as set forth below to determine if return of any item is required, or if repairs can be made by the user in the field. Any warranty or other claim with respect to the products must be made with sufficient evidence of purchase and date of receipt, otherwise user's rights under this warranty shall be deemed waived.

For PACE USA Customers:

PACE, INCORPORATED  
9030 Junction Drive  
Annapolis Junction, Maryland 20701  
Tel. 301-317-3588  
FAX: 301-498-3252

For PACE EUROPE Customers:

PACE EUROPE LIMITED  
13 Tanners Drive  
Blakelands, Milton Keynes  
MK 14 5BU  
United Kingdom  
Tel. (44) 1908 277666  
WARRANTY SERVICE FAX: (44) 1908 277 777

All other Customers:

Local Authorized PACE Distributor



PACE Incorporated retains the right to make changes to specifications contained herein at any time, without notice. Contact your local authorized PACE Distributor or PACE Incorporated to obtain the latest specifications.

The following are trademarks and/or service marks of PACE, Incorporated, MD, USA:

INSTACAL™, FUMEFLO™, HEATWISE™, PACEWORLDWIDE™, PERMAGROUND™, POWERPORT™, POWERMODULE™, TEMPWISE™, TIP-BRITE™, AUTO-OFF™, and TEKLINK™.

The following are registered trademarks and/or service marks of PACE Incorporated, Annapolis Junction Maryland U.S.A.

ARM-EVAC®, FLO-D-SODR®, MINIWAVE®, PACE®, SENSATEMP®, SNAP-VAC®, SODRTEK®, SODR-X-TRACTOR®, THERMOFLO®, THERMOJET®, THERMOTWEEZ®, VISIFILTER®, THERMO-DRIVE®, and TOOLNET®.

PACE products meet or exceed all applicable military and civilian EOS/ESD, temperature stability and other specifications including MIL STD 2000, ANSI/JSTD 001, IPC7711, and IPC A-610.



[www.paceworldwide.com](http://www.paceworldwide.com)

**PACE USA**

9030 Junction Drive  
Annapolis Junction, MD 20701  
USA

Tel: (301) 490-9860  
Fax: (301) 498-3252

**PACE Europe**

13 Tanners Drive  
Blakelands, Milton Keynes  
MK7 8HX  
United Kingdom

(44) 01908-277666  
(44) 01908-277777